

SUMMARY OF PRODUCT CHARACTERISTICS

1. NAME OF THE MEDICINAL PRODUCT

Kyleena 19.5 mg intrauterine delivery system.

2. QUALITATIVE AND QUANTITATIVE COMPOSITION

The intrauterine delivery system contains 19.5 mg levonorgestrel.

For the full list of excipients, see section 6.1.

For details of release rates, see section 5.2.

3. PHARMACEUTICAL FORM

Intrauterine delivery system (IUS).

The product consists of a whitish or pale yellow drug core covered with a semi-opaque membrane, which is mounted on the vertical stem of a T-body. In addition, the vertical stem contains a silver ring located close to the horizontal arms. The white T-body has a loop at one end of the vertical stem and two horizontal arms at the other end. The blue coloured removal threads are attached to the loop. The vertical stem of the IUS is loaded in the insertion tube at the tip of the inserter. The inserter consists of a handle and slider that are integrated with flange, lock, pre-bent insertion tube and plunger. The removal threads are located within the insertion tube and handle.

Dimensions of Kyleena: 28 x 30 x 1.55 mm

4. CLINICAL PARTICULARS

4.1 Therapeutic indications

Contraception for up to 5 years.

4.2 Posology and method of administration

Posology

Kyleena is inserted into the uterine cavity and is effective for up to 5 years.

Insertion and removal/replacement

It is recommended that Kyleena should only be inserted by physicians/healthcare professionals who are experienced in IUS insertions and/ or have undergone training on the Kyleena insertion procedure.

Kyleena is to be inserted into the uterine cavity within 7 days of the onset of menstruation. Kyleena can be replaced by a new system at any time in the cycle. Kyleena can also be inserted immediately after first trimester abortion.

Postpartum insertions should be postponed until the uterus is fully involuted, however not earlier than 6 weeks after delivery. If involution is substantially delayed, consider waiting until 12 weeks postpartum.

In case of a difficult insertion and/ or exceptional pain or bleeding during or after insertion, the possibility of perforation should be considered and appropriate steps should be taken, such as physical examination and ultrasound. Physical examination may not be sufficient to exclude partial perforation.

Kyleena can be distinguished from other IUSs by the combination of the visibility of the silver ring on ultrasound and the blue colour of the removal threads. The T-frame of Kyleena contains barium sulfate which makes it visible in X-ray examination.

Kyleena is removed by gently pulling on the threads with a forceps. If the threads are not visible and the system is found to be in the uterine cavity on ultrasound examination, it may be removed using a narrow forceps. This may require dilatation of the cervical canal or surgical intervention.

The system should be removed no later than by the end of the fifth year. If the woman wishes to continue using the same method, a new system can be inserted immediately following removal of the original system.

If pregnancy is not desired, the removal should be carried out within 7 days of the onset of menstruation, provided the woman is experiencing regular menses. If the system is removed at some other time during the cycle or the woman does not experience regular menses and the woman has had intercourse within a week, she is at risk of pregnancy. To ensure continuous contraception a new system should be immediately inserted or an alternative contraceptive method should have been initiated.

After removal of Kyleena, the system should be examined to ensure that it is intact.

Elderly

Kyleena is not indicated for use in postmenopausal women.

Hepatic impairment

Kyleena has not been studied in women with hepatic impairment. Kyleena is contraindicated in women with acute liver disease or liver tumour (see section 4.3).

Renal impairment

Kyleena has not been studied in women with renal impairment.

Paediatric population

Use of this product before menarche is not indicated. For data on safety and efficacy in adolescents, see section 5.1.

Method of administration

To be inserted by a healthcare professional using aseptic technique.

Kyleena is supplied in a sterile package within an integrated inserter that enables single handed loading. The package should not be opened until needed for insertion. Do not resterilize. As supplied, Kyleena is for single use only. Do not use if the blister is damaged or open. Do not insert after the expiry date which is stated on the carton and the blister after EXP.

Any unused product or waste material should be disposed of in accordance with local requirements.

Kyleena is supplied with a patient reminder card in the outer carton. Complete the patient reminder card and give it to the patient, after insertion.

Preparation for insertion

- Examine the patient to establish the size and position of the uterus, in order to detect any signs of acute genital infections or other contraindications for the insertion of Kyleena. If there is any doubt regarding pregnancy, a pregnancy test should be performed.
- Insert a speculum, visualize the cervix, and then thoroughly cleanse the cervix and vagina with a suitable antiseptic solution.
- Employ an assistant as necessary.
- Grasp the anterior lip of the cervix with a tenaculum or other forceps to stabilize the uterus. If the uterus is retroverted, it may be more appropriate to grasp the posterior lip of the cervix. Gentle traction on the forceps can be applied to

straighten the cervical canal. The forceps should remain in position and gentle counter traction on the cervix should be maintained throughout the insertion procedure.

- Advance a uterine sound through the cervical canal to the fundus to measure the depth and confirm the direction of the uterine cavity and to exclude any evidence of intrauterine abnormalities (e.g., septum, submucous fibroids) or a previously inserted intrauterine contraceptive which has not been removed. If difficulty is encountered, consider dilatation of the canal. If cervical dilatation is required, consider using analgesics and/or a paracervical block.

Insertion

1. First, open the sterile package completely (Figure 1). Then use aseptic technique and sterile gloves.

Figure 1

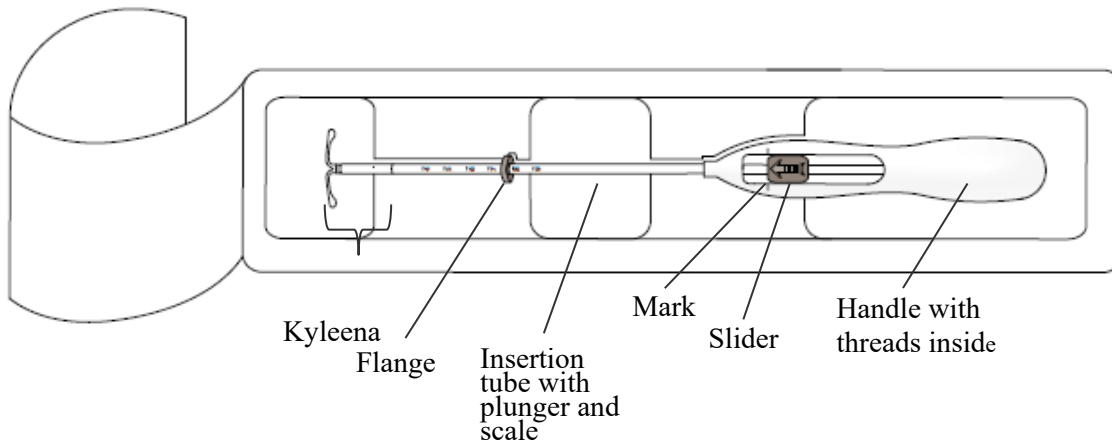

2. Push the slider **forward** in the direction of the arrow to the furthest position to load Kyleena into the insertion tube (Figure 2).

Figure 2

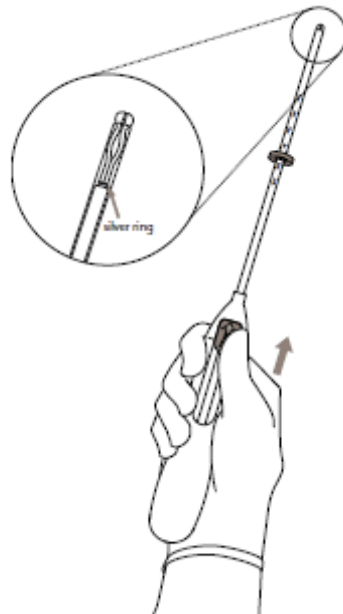

IMPORTANT! Do not pull the slider downwards as this may prematurely release Kyleena. Once

released, Kyleena cannot be re-loaded.

3. Holding the slider in the furthest position, set the **upper** edge of the flange to correspond to the sound measurement of the uterine depth (Figure 3).

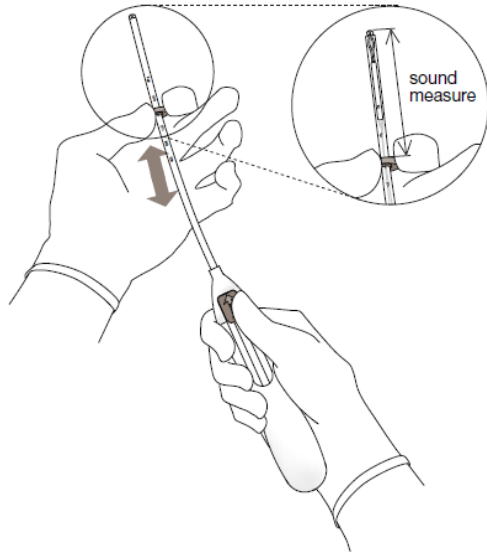

Figure 3

4. While holding the slider in the **furthest** position, advance the inserter through the cervix until the flange is approximately 1.5-2.0 cm from the uterine cervix (Figure 4).

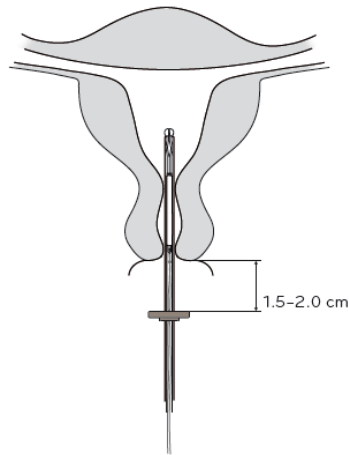

Figure 4

IMPORTANT! Do not force the inserter. Dilate the cervical canal, if necessary.

5. While holding the inserter steady, **pull the slider to the mark** to open the horizontal arms of Kyleena (Figure 5). Wait 5 -10 seconds for the horizontal arms to open completely.

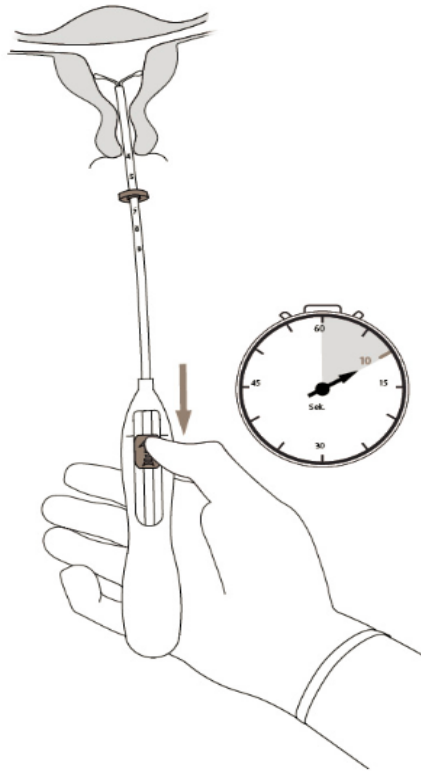

Figure 5

6. Advance the inserter gently towards the fundus of the uterus **until the flange touches the cervix**. Kyleena is now in the fundal position (Figure 6).

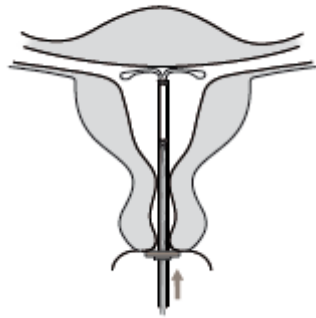
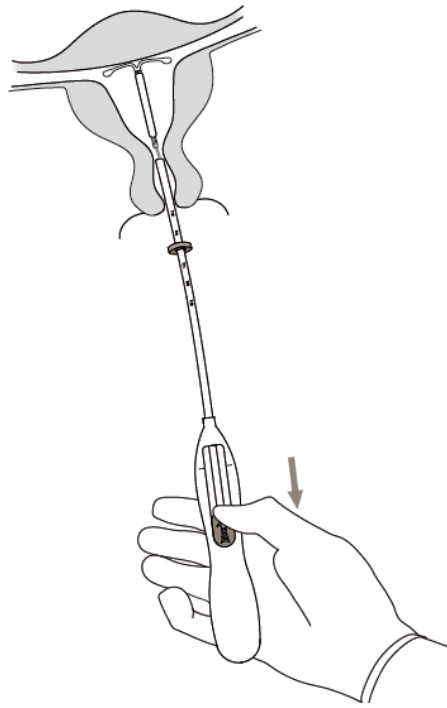

Figure 6

7. Holding the inserter in place, release Kyleena by pulling **the slider all the way down** (Figure 7). While holding the slider all the way down, gently remove the inserter by pulling it out. **Cut the threads** to leave about 2-3 cm visible outside of the cervix.

Figure 7



IMPORTANT! Should you suspect that the system is not in the correct position, check placement (e.g. with ultrasound). Remove the system if it is not positioned properly within the uterine cavity. A removed system must not be re-inserted.

Removal/replacement

For removal/replacement, please see section 4.2 *Insertion and removal/replacement*.

Kyleena is removed by pulling on the threads with a forceps (Figure 8).

You may insert a new Kyleena immediately following removal.

After removal of Kyleena, the system should be examined to ensure that it is intact.

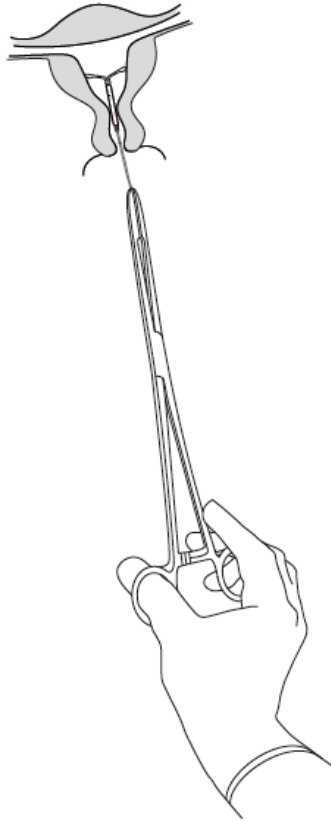

Figure 8

4.3 Contraindications

- Pregnancy (see section 4.6);
- Acute or recurrent pelvic inflammatory disease or conditions associated with increased risk for pelvic infections;
- Acute cervicitis or vaginitis;
- Postpartum endometritis or infected abortion during the past three months;
- Cervical intraepithelial neoplasia until resolved;
- Uterine or cervical malignancy;
- Progestogen-sensitive tumours, e.g. breast cancer;
- Abnormal uterine bleeding of unknown aetiology;
- Congenital or acquired uterine anomaly including fibroids which would interfere with insertion and / or retention of the intrauterine system (i.e. if they distort the uterine cavity);
- Acute liver disease or liver tumour;
- Hypersensitivity to the active substance or to any of the excipients listed in section 6.1.

4.4 Special warnings and precautions for use

Kyleena should be used with caution after specialist consultation, or removal of the system should be considered if any of the following conditions exist or arise for the first time:

- migraine, focal migraine with asymmetrical visual loss or other symptoms indicating transient cerebral ischemia
- exceptionally severe headache
- jaundice
- marked increase of blood pressure
- severe arterial disease such as stroke or myocardial infarction

Low-dose levonorgestrel may affect glucose tolerance, and the blood glucose concentration should be monitored in diabetic users of Kyleena. However, there is generally no need to alter the therapeutic regimen in diabetics using levonorgestrel- IUS.

Medical examination/consultation

Before insertion, a woman must be informed of the benefits and risks of Kyleena, including the signs and symptoms of perforation and the risk of ectopic pregnancy, see below. A physical examination including pelvic examination and examination of the breasts should be conducted. Cervical smear should be performed as needed, according to healthcare professional's evaluation. Pregnancy and sexually transmitted diseases should be excluded. Genital infections should be successfully treated prior to insertion. The position of the uterus and the size of the uterine cavity should be determined. Fundal positioning of Kyleena is important in order to maximize the efficacy and reduce the risk of expulsion. The instructions for the insertion should be followed carefully.

Emphasis should be given to training in the correct insertion technique.

Insertion and removal may be associated with some pain and bleeding. The procedure may precipitate a vasovagal reaction (e.g. syncope, or a seizure in an epileptic patient).

A woman should be re-examined 4 to 6 weeks after insertion to check the threads and ensure that the system is in the correct position. Follow-up visits are recommended once a year thereafter, or more frequently if clinically indicated.

Kyleena is not for use as a post-coital contraceptive.

The use of Kyleena for the treatment of heavy menstrual bleeding or protection from endometrial hyperplasia during oestrogen replacement therapy has not been established. Therefore it is not recommended for use in these conditions.

Ectopic pregnancy

In clinical trials, the overall incidence of ectopic pregnancy with Kyleena was approximately 0.20 per 100 women-years. Approximately half of the pregnancies that occur during Kyleena use are likely to be ectopic.

Women considering Kyleena should be counselled on the signs, symptoms and risks of ectopic pregnancy. For women who become pregnant while using Kyleena, the possibility of an ectopic pregnancy must be considered and evaluated.

Women with a previous history of ectopic pregnancy, tubal surgery or pelvic infection carry an increased risk of ectopic pregnancy. The possibility of ectopic pregnancy should be considered in the case of lower abdominal pain, especially in connection with missed periods or if an amenorrhoeic woman starts bleeding.

Because an ectopic pregnancy may impact future fertility the benefits and risks of using Kyleena should be carefully evaluated on an individual woman basis.

Effects on the menstrual bleeding pattern

Effects on the menstrual bleeding pattern are expected in most users of Kyleena. Those alterations are a result of the direct action of levonorgestrel on the endometrium and may not correlate with the ovarian activity.

Irregular bleeding and spotting are common in the first months of use. Thereafter, the strong suppression of the endometrium results in the reduction of the duration and volume of menstrual bleeding. Scanty flow frequently develops into oligomenorrhoea or amenorrhoea.

In clinical trials, infrequent bleeding and/or amenorrhoea developed gradually. By the end of the fifth year about 26.4% and 22.6% of the users developed infrequent bleeding and/or amenorrhoea, respectively. Pregnancy should be considered if menstruation does not occur within 6 weeks of the onset of previous menstruation. A repeated pregnancy test is not necessary in subjects who remain amenorrhoeic unless indicated by other signs of pregnancy.

If bleeding becomes heavier and/or more irregular over time, appropriate diagnostic measures should be taken as irregular bleeding may be a symptom of endometrial polyps, hyperplasia or cancer and heavy bleeding may be a sign of unnoticed expulsion of the IUS.

Pelvic infection

Pelvic infection has been reported during use of any IUS or IUD. While Kyleena and the inserter are sterile they may, due to bacterial contamination during insertion, become a vehicle for microbial transport in the upper genital tract. In clinical trials, pelvic inflammatory disease (PID) was observed more frequently at the beginning of Kyleena use, which is consistent with published data for copper IUDs, where the highest rate of PID occurs during the first 3 weeks after insertion and decreases thereafter.

Before electing use of Kyleena, patients should be fully evaluated for risk factors associated with pelvic infection (e.g. multiple sexual partners, sexually transmitted infections, prior history of PID). Pelvic infections such as PID may have serious consequences and may impair fertility and increase the risk of ectopic pregnancy.

As with other gynaecological or surgical procedures, severe infection or sepsis (including group A streptococcal sepsis) can occur following IUD insertion, although this is extremely rare.

If a woman experiences recurrent endometritis or pelvic inflammatory disease or if an acute infection is severe or does not respond to treatment, Kyleena must be removed.

Bacteriological examinations are indicated and monitoring is recommended, even with discrete symptoms indicative of infections.

Expulsion

In clinical trials with Kyleena, the incidence of expulsion was low (<4% of insertions) and in the same range as that reported for other IUDs and IUSs. Symptoms of the partial or complete expulsion of Kyleena may include bleeding or pain. However, partial or complete expulsion can occur without the woman noticing it, leading to decrease or loss of contraceptive protection. As Kyleena typically decreases menstrual bleeding over time, an increase of menstrual bleeding may be indicative of an expulsion.

Risk of expulsion is increased in

- Women with history of heavy menstrual bleeding
- Women with greater than normal BMI at the time of insertion; this risk increases gradually with increasing BMI

Women should be counselled on possible signs of expulsion and how to check the threads of Kyleena and advised to contact a healthcare professional if the threads cannot be felt. A barrier contraceptive (such as a condom) should be used until the location of Kyleena has been confirmed.

A partially expelled Kyleena should be removed. A new system can be inserted at the time of removal, provided pregnancy has been excluded.

Perforation

Perforation or penetration of the uterine corpus or cervix by an intrauterine contraceptive may occur, most often during insertion, although it may not be detected until sometime later, and may decrease the effectiveness of Kyleena. In case of a difficult insertion and/or exceptional pain or bleeding during or after insertion, appropriate steps should be taken immediately to exclude perforation, such as physical examination and ultrasound. Such a system must be removed; surgery may be required.

In a large prospective comparative non-interventional cohort study in users of other IUDs (N=61448 women) with a 1-year observational period, the incidence of perforation was 1.3 (95% CI: 1.1-1.6) per 1000 insertions in the entire study cohort; 1.4 (95% CI: 1.1-1.8) per 1000 insertions in the cohort of another levonorgestrel-IUS and 1.1 (95% CI: 0.7-1.6) per 1000 insertions in the copper IUD cohort.

The study showed that both breastfeeding at the time of insertion and insertion up to 36 weeks after giving birth were associated with an increased risk of perforation (see Table 1). Both risk factors were independent of the type of IUD inserted.

Table 1: Incidence of perforation per 1000 insertions for the entire study cohort observed over 1 year, stratified by breastfeeding and time since delivery at insertion (parous women)

	Breastfeeding at time of insertion	Not breastfeeding at time of insertion
Insertion ≤ 36 weeks after delivery	5.6 (95% CI: 3.9-7.9, n=6047 insertions)	1.7 (95% CI: 0.8-3.1, n=5927 insertions)
Insertion > 36 weeks after delivery	1.6 (95% CI: 0.0-9.1, n=608 insertions)	0.7 (95% CI: 0.5-1.1, n=41910 insertions)

Extending the observational period to 5 years in a subgroup of this study (N=39009 women inserted with another levonorgestrel-IUS or copper IUD, 73% of these women had information available over the complete 5 years of follow-up), the incidence of perforation detected at any time during the entire 5-year period was 2.0 (95% CI: 1.6 – 2.5) per 1000 insertions. Breastfeeding at the time of insertion and insertion up to 36 weeks after giving birth were confirmed as risk factors also in the subgroup that were followed up for 5 years.

The risk of perforations may be increased in women with fixed retroverted uterus.

Re-examination after insertion should follow the guidance given under the heading "Medical examination/consultation" which may be adapted as clinically indicated in women with risk factors for perforation.

Lost threads

If the removal threads are not visible at the cervix on follow-up examinations, unnoticed expulsion and pregnancy must be excluded. The threads may have been drawn up into the uterus or cervical canal and may reappear during the next menstrual period. If pregnancy has been excluded, the threads may usually be located by gently probing the cervical canal with a suitable instrument. If they cannot be found, the possibility of expulsion or perforation should be considered. Ultrasound examination may be used to ascertain the position of the system. If ultrasound is not available or is not successful, X-ray may be used to locate Kyleena.

Ovarian cysts/enlarged ovarian follicles

Since the contraceptive effect of Kyleena is mainly due to its local effects within the uterus, there is generally no change in ovulatory function, including regular follicular development, oocyte release and follicular atresia in women of fertile age. Sometimes atresia of the follicle is delayed and folliculogenesis may continue. These enlarged follicles cannot be distinguished clinically from ovarian cysts. Ovarian cysts (including haemorrhagic ovarian cysts and ruptured ovarian cysts) have been reported over the course of the clinical trials as adverse event at least once in approximately 22.2% of women using Kyleena. Most of these cysts are asymptomatic, although some may be accompanied by pelvic pain or dyspareunia.

In most cases, the enlarged follicles resolve spontaneously over two to three months observation. Should an enlarged follicle fail to resolve spontaneously, continued ultrasound monitoring and other diagnostic/ therapeutic measures may be appropriate. Rarely, surgical intervention may be required.

Psychiatric disorders

Depressed mood and depression are well-known undesirable effects of hormonal contraceptive use (see section 4.8). Depression can be serious and is a well-known risk factor for suicidal behaviour and suicide. Women should be advised to contact their physician in case of mood changes and depressive symptoms, including shortly after initiating the treatment.

4.5 Interaction with other medicinal products and other forms of interaction

Note: The prescribing information of concomitant medications should be consulted to identify potential interactions.

Effects of other medicinal products on Kyleena

Interactions can occur with medicinal products that induce microsomal enzymes, which can result in increased clearance of sex hormones.

Substances increasing the clearance of levonorgestrel, e.g.:

Phenytoin, barbiturates, primidone, carbamazepine, rifampicin, and possibly also oxcarbazepine, topiramate, felbamate, griseofulvin, and products containing St. John's wort.

The influence of these medicinal products on the contraceptive efficacy of Kyleena is not known, but it is not believed to be of major importance due to the local mechanism of action.

Substances with variable effects on the clearance of levonorgestrel, e.g.:

When co-administered with sex hormones, many HIV/HCV protease inhibitors and non-nucleoside reverse transcriptase inhibitors can increase or decrease plasma concentrations of the progestin.

Substances decreasing the clearance of levonorgestrel (enzyme inhibitors):

Strong and moderate CYP3A4 inhibitors such as azole antifungals (e.g. fluconazole, itraconazole, ketoconazole, voriconazole), verapamil, macrolides (e.g. clarithromycin, erythromycin), diltiazem and grapefruit juice can increase plasma concentrations of the progestin.

Magnetic resonance imaging (MRI)

Non-clinical testing of another levonorgestrel-IUS with the same size silver ring and T-body has demonstrated that a patient can be scanned safely after placement of Kyleena (MR conditional) under the following conditions:

- Static magnetic field of 3-Tesla or less,
- Spatial gradient field of 36000 Gauss/cm (360 T/m) or less
- Maximum whole body averaged specific absorption rate (SAR) of 4 W/kg in the First Level Controlled mode for 15 minutes of continuous scanning

In non-clinical testing, the aforementioned levonorgestrel-IUS produced a temperature rise of equal to or less than 1.8°C at a maximum whole body averaged specific absorption rate (SAR) of 2.9 W/kg, for 15 minutes of MR scanning at 3 T using a transit/receive body coil.

A small amount of imaging artifact may occur if the area of interest is in the same area or relatively close to the position of Kyleena.

4.6 Fertility, pregnancy and lactation

Fertility

The use of a levonorgestrel-releasing intrauterine system does not alter the course of future fertility. Upon removal of the intrauterine system, women return to their normal fertility (see section 5.1).

Pregnancy

The insertion of Kyleena in pregnant women is contraindicated (see section 4.3).

If a woman becomes pregnant while using Kyleena ectopic pregnancy should be excluded and the system should be removed as soon as possible, since any intrauterine contraceptive left in situ may increase the risk of abortion and preterm labour. Removal of Kyleena or probing of the uterus may also result in spontaneous abortion. If the woman wishes to continue the pregnancy and the system cannot be withdrawn, she should be informed about the risks and the possible consequences of premature birth to the infant. The course of such a pregnancy should be closely monitored. The woman should be instructed to report all symptoms that suggest complications of the pregnancy, like cramping abdominal pain with fever.

In addition, an increased risk of virilising effects in a female foetus because of the intrauterine exposure to levonorgestrel cannot be excluded. There have been isolated cases of masculinization of the external genitalia of the female foetus following local exposure to levonorgestrel during pregnancy with an LNG-IUS in place.

Breast-feeding

In general, there appears to be no deleterious effect on infant growth or development when using any progestogen-only method after 6 weeks postpartum. A levonorgestrel-releasing intrauterine system does not affect the quantity or quality of breast milk. Small amounts of progestogen (about 0.1% of the levonorgestrel dose) pass into the breast milk in nursing mothers.

4.7 Effects on ability to drive and use machines

Kyleena has no known influence on the ability to drive or use machines.

4.8 Undesirable effects

Summary of the safety profile

The majority of women experience changes in menstrual bleeding pattern after insertion of Kyleena. Over time, the frequency of amenorrhoea and infrequent bleeding increases, and the frequency of prolonged, irregular and frequent bleeding decreases. The following bleeding patterns were observed in clinical trials:

Table 2: Bleeding patterns reported with Kyleena in clinical trials

Kyleena	First 90 days	Second 90 days	End of year 1	End of year 3	End of year 5
Amenorrhoea	< 1%	5%	12%	20%	23%
Infrequent bleeding	10%	20%	26%	26%	26%
Frequent bleeding	25%	10%	4%	2%	2%
Prolonged bleeding*	57%	14%	6%	2%	1%
Irregular bleeding	43%	25%	17%	10%	9%

*Subjects with prolonged bleeding may also be included in one of the other categories (excluding amenorrhoea)

Tabulated summary of adverse events

The frequencies of Adverse Drug Reactions (ADRs) reported with Kyleena are summarized in the table below. Within each frequency grouping, undesirable effects are presented in order of decreasing seriousness. Frequencies are defined as:

- very common ($\geq 1/10$),
- common ($\geq 1/100$ to $< 1/10$),
- uncommon ($\geq 1/1,000$ to $< 1/100$),
- rare ($\geq 1/10,000$ to $< 1/1,000$),
- very rare ($< 1/10,000$).

System Organ Class	Very Common	Common	Uncommon
Psychiatric disorders		Depressed mood/Depression Decreased libido	
Nervous system disorders	Headache	Migraine	
Vascular disorders		Dizziness	
Gastrointestinal disorders	Abdominal/pelvic pain	Nausea	
Skin and subcutaneous tissue disorders	Acne/Seborrhoea	Alopecia	Hirsutism
Reproductive system and breast disorders	Bleeding changes including increased and decreased menstrual bleeding, spotting, infrequent bleeding and amenorrhoea Ovarian cyst* Vulvovaginitis	Upper genital tract infection Dysmenorrhoea Breast pain/discomfort Device expulsion (complete and partial) Genital discharge	Uterine perforation**
Investigations		Increased weight	

* In clinical trials ovarian cysts had to be reported as AEs if they were abnormal, non-functional cysts and/or had a diameter > 3 cm on ultrasound examination.

** This frequency is based on a large prospective comparative non-interventional cohort study with women using another levonorgestrel-IUS and copper IUDs which showed that breastfeeding at the time of insertion and insertion up to 36 weeks after giving birth are independent risk factors for perforation (see section 4.4 under Perforation). In clinical trials with Kyleena that excluded breastfeeding women the frequency of perforation was "rare".

Description of selected adverse reactions

With the use of levonorgestrel-IUS, cases of hypersensitivity including rash, urticaria and angioedema have been reported.

If a woman becomes pregnant while using Kyleena, the relative likelihood of this pregnancy being ectopic is increased (see section 4.4 under Ectopic Pregnancy).

The removal threads may be felt by the partner during intercourse.

The following ADRs have been reported in connection with the insertion or removal procedure of Kyleena: Procedural pain, procedural bleeding, insertion-related vasovagal reaction with dizziness or syncope. The procedure may precipitate a seizure in an epileptic patient.

Cases of sepsis (including group A streptococcal sepsis) have been reported following IUD insertion (see section 4.4 under Pelvic Infection).

Paediatric population

The safety profile of Kyleena is expected to be the same for adolescents under the age of 18 as for users 18 years and older. For data on safety in adolescents, see section 5.1.

Reporting of suspected adverse reactions

Reporting suspected adverse reactions after authorisation of the medicinal product is important. It allows continued monitoring of the benefit/risk balance of the medicinal product. Healthcare professionals are asked to report any suspected adverse reactions via HPRA Pharmacovigilance, website: www.hpra.ie.

4.9 Overdose

Not relevant.

5. PHARMACOLOGICAL PROPERTIES

5.1 Pharmacodynamic properties

Pharmacotherapeutic group: Plastic IUD with progestogen, ATC code: G02BA03

Pharmacodynamic effects

Kyleena has mainly local progestogenic effects in the uterine cavity.

The high levonorgestrel concentration in the endometrium down-regulates endometrial oestrogen and progesterone receptors. The endometrium becomes relatively insensitive to the circulating estradiol and a strong antiproliferative effect is seen. Morphological changes of the endometrium and a weak local foreign body reaction are observed during use. Thickening of the cervical mucus prevents passage of the sperm through the cervical canal. The local milieu of the uterus and of the fallopian tubes inhibits sperm mobility and function, preventing fertilization. In clinical trials with Kyleena ovulation was observed in the majority of the subset of women studied. Evidence of ovulation was seen in 23 out of 26 women in the first year, in 19 out of 20 women in the second year and in all 16 women in the third year. In the fourth year, evidence of ovulation was observed in the one woman remaining in the subset and in the fifth year, no women remained in this subset.

Clinical efficacy and safety

The contraceptive efficacy of Kyleena has been evaluated in a clinical study with 1452 women aged 18-35 including 39.5% (574) nulliparous women of whom 84.0% (482) were nulligravid using Kyleena.

The 1-year Pearl Index was 0.16 (95% confidence limits 0.02 – 0.58) and the 5-years Pearl Index was 0.29 (95% confidence limits 0.16 – 0.50). The failure rate was approximately 0.2% at 1 year and the cumulative failure rate was approximately 1.4% at 5 years. The failure rate also includes pregnancies occurring after undetected expulsions and perforations. Use of a levonorgestrel releasing intrauterine system does not alter the course of future fertility. In a 5-year study with Kyleena, 116 out of 163 (71.2%) women who discontinued because of the wish for pregnancy had become pregnant during the 12-month follow-up.

The safety profile of another lower-dose levonorgestrel-IUS observed in a study of 304 adolescents was consistent with that in the adult population. Efficacy is expected to be the same for adolescents under the age of 18 as for users 18 years and older.

With Kyleena, the alterations in menstrual patterns are a result of the direct action of levonorgestrel on the endometrium and may not reflect the ovarian cycle. There is no clear difference in follicle development, ovulation or estradiol and progesterone production in women with different bleeding patterns. In the process of inhibition of the endometrial proliferation, there can be an initial increase of spotting during the first months of use. Thereafter, the strong suppression of the endometrium results in the reduction of the duration and volume of menstrual bleeding during use of Kyleena. Scanty flow frequently develops into oligomenorrhoea or amenorrhoea. Ovarian function remains normal and estradiol levels are maintained, even when users of Kyleena are amenorrhoeic.

5.2 Pharmacokinetic properties

Levonorgestrel is released locally into the uterine cavity. The *in vivo* release curve is characterized by an initial steep decline that slows down progressively resulting in little change after 1 year until the end of the intended 5-year period of use. Estimated *in vivo* delivery rates for different time points are provided in Table 3.

Table 3: Estimated *in vivo* release rates based on observed *ex vivo* residual content data

Time	Estimated <i>in vivo</i> release rate [micrograms/24 hours]
24 days after insertion	17.5
60 days after insertion	15.3
1 year after insertion	9.8
3 years after insertion	7.9
5 years after insertion	7.4
Average over 1st year	12.6
Average over 5 years	9.0

Absorption

Following insertion, levonorgestrel is released from the IUS into the uterine cavity without delay. More than 90% of the released levonorgestrel is systemically available. Maximum serum concentrations of levonorgestrel are reached within the first two weeks after insertion of Kyleena. Seven days after insertion, a mean levonorgestrel concentration of 162 pg/ml (5th percentile: 81 pg/ml – 95th percentile: 308 pg/ml) was determined. Thereafter serum concentrations of levonorgestrel decline over time to reach mean concentrations of 91 pg/ml (5th percentile: 47 pg/ml – 95th percentile: 170 pg/ml) after 3 years and 83 pg/ml (5th percentile: 45 pg/ml – 95th percentile: 153 pg/ml) after 5 years. With the use of a levonorgestrel-releasing intrauterine system, the high local drug exposure in the uterine cavity leads to a strong concentration gradient from the endometrium to the myometrium (gradient endometrium to myometrium > 100-fold), and to low concentrations of levonorgestrel in serum (gradient endometrium to serum > 1000-fold).

Distribution

Levonorgestrel is bound non-specifically to serum albumin and specifically to SHBG. Less than 2% of the circulating levonorgestrel is present as free steroid. Levonorgestrel binds with high affinity to SHBG. Accordingly, changes in the concentration of SHBG in serum result in an increase (at higher SHBG concentrations) or in a decrease (at lower SHBG concentrations) of the total levonorgestrel concentration in serum. The concentration of SHBG declined on average by about 30% during the first 3 months after insertion of Kyleena and remained relatively stable over the 5 year period of use. The mean apparent volume of distribution of levonorgestrel is about 106 L.

Biotransformation

Levonorgestrel is extensively metabolized. The most important metabolic pathways are the reduction of the Δ 4-3-oxo group and hydroxylations at positions 2 α , 1 β and 16 β , followed by conjugation. CYP3A4 is the main enzyme involved in the oxidative metabolism of levonorgestrel. The available *in vitro* data suggest that CYP mediated biotransformation reactions may be of minor relevance for levonorgestrel compared to reduction and conjugation.

Elimination

The total clearance of levonorgestrel from plasma is approximately 1.0 ml/min/kg. Only trace amounts of levonorgestrel are excreted in unchanged form. The metabolites are excreted in faeces and urine at an excretion ratio of about 1. The excretion half-life is about 1 day.

Linearity/non-linearity

The pharmacokinetics of levonorgestrel are dependent on the concentration of SHBG which itself is influenced by oestrogens and androgens. A decrease of SHBG concentration leads to a decrease of total levonorgestrel concentration in serum indicating non-linear pharmacokinetics of levonorgestrel with regard to time. Based on the mainly local action of Kyleena, no impact on the efficacy of Kyleena is expected.

Paediatric population

In a one-year phase III study in post-menarcheal female adolescents (mean age 16.2, range 12 to 18 years) using another lower-dose levonorgestrel-IUS the pharmacokinetic analysis of 283 adolescents showed estimated levonorgestrel serum

concentrations slightly higher (approximately 10%) in adolescents compared to adults. This correlates to the generally lower body weight in adolescents. The ranges estimated for adolescents lie, however, within the ranges estimated for adults, showing high similarity.

No differences in the pharmacokinetics of adolescents and adults are expected with Kyleena.

Ethnic differences

A three-year phase III study in the Asian-Pacific region (93% Asian women, 7% other ethnicities) using another lower-dose levonorgestrel-IUS has been performed. A comparison of pharmacokinetic characteristics of levonorgestrel of the Asian population in this study with the Caucasian population from another phase III study showed no clinically relevant difference in systemic exposure and other pharmacokinetic parameters. In addition, the daily release rate of the levonorgestrel containing IUS was the same in both populations.

No pharmacokinetic differences in women of different ethnicities are expected with Kyleena.

5.3 Preclinical safety data

Nonclinical data revealed no special hazard for humans based on studies of safety pharmacology, pharmacokinetics and toxicity, including genotoxicity and carcinogenic potential of levonorgestrel. Studies in monkeys with intrauterine delivery of levonorgestrel for 9 to 12 months confirmed local pharmacological activity with good local tolerance and no signs of systemic toxicity. No embryotoxicity was seen in rabbits following intrauterine administration of levonorgestrel.

The safety evaluation of the elastomer components of the hormone reservoir, polyethylene and polypropylene materials as well as the silver ring of the product, and combination of elastomer and levonorgestrel, based on both the assessment of genetic toxicology in standard *in vitro* and *in vivo* test systems and on biocompatibility tests in mice, rats, guinea pigs, rabbits and *in vitro* test systems have not revealed bio-incompatibility.

Environmental risk assessment (ERA)

Environmental risk assessment studies have shown that levonorgestrel may pose a risk to the aquatic environment (see section 6.6).

6. PHARMACEUTICAL PARTICULARS

6.1 List of excipients

Polydimethylsiloxane elastomer
Silica, colloidal anhydrous
Polyethylene
Barium sulfate
Polypropylene
Copper phthalocyanine
Silver

6.2 Incompatibilities

Not applicable.

6.3 Shelf life

3 years.

6.4 Special precautions for storage

This medicinal product does not require any special storage conditions.

6.5 Nature and contents of container

The product is individually packed into a thermoformed blister package (PETG) with a peelable lid (PE).

Pack sizes: 1x1 and 5x1.

Not all pack sizes may be marketed.

6.6 Special precautions for disposal and other handling

The product is supplied in a sterile package which should not be opened until required for insertion. Each system should be handled with aseptic precautions. If the seal of the sterile envelope is broken, the system inside should be disposed of in accordance with local guidelines for the handling of biohazardous waste. Likewise, a removed Kyleena and inserter should be disposed of in this manner.

To be inserted by a healthcare professional using aseptic technique (see section 4.2).

Any unused medicinal product or waste material should be disposed of in accordance with local requirements. This medicinal product may pose a risk to the environment (see section 5.3).

7. MARKETING AUTHORISATION HOLDER

Bayer Limited
The Atrium
Blackthorn Road
Dublin 18
Ireland

8. MARKETING AUTHORISATION NUMBER(S)

PA1410/081/001

9. DATE OF FIRST AUTHORISATION/RENEWAL OF THE AUTHORISATION

Date of first authorisation: 16th December 2016

Date of last renewal: 3rd October 2021

10. DATE OF REVISION OF THE TEXT

September 2021